

Lycra blend knit fabrics make excellent waistbands that are both comfortable and figure flattering. Consider a smooth fabric waistband that can sit at the waist, hips or anywhere in between. This waistband can be folded, crushed or worn flat depending on the day's desired effect.

This type of waistband helps achieve a wonderfully smooth transition at the waist, which has always been an issue with an elastic waist. No casings, pins or topstitching involved. Great!

Soft-hand, jersey type LYCRA blend fabrics with at least 100% crosswise stretch and good recovery work best. A simple alteration is all that is needed to make the change to your pattern. By removing a portion of the garment and replacing it with a band the garment will still fit properly, just smoother. Depending on the desired width of the band the pattern alteration varies. Calculating the band length is easy using the measurement information included here. The suggested patterns and fabrics work out great using this technique.

Print and keep the handy PDF file in a Cut Two notebook. Every month you will receive a new file to add.

Read over the simple instructions and then view the garment photos using this great technique. The fabrics and patterns shown are all available on my website.

Happy Sewing!
Christine

REPLACE AN ELASTIC BAND WITH A FABRIC BAND

This can easily be done on the Taper Pant (824), Wide Leg Pant (824), Straight Skirt (1025), Taper Skirt (1025), Swirl Skirt (419) or A-Line Skirt (1219).

- The fabric for the band must have at least 100% crosswise stretch.
- Choose your band measurements based on the Band Measurement Chart on the next page.

- Trim the top of the pattern pieces by 4-3/4" for the wide band or 3-7/8" for the narrow band following the curve of the pattern.

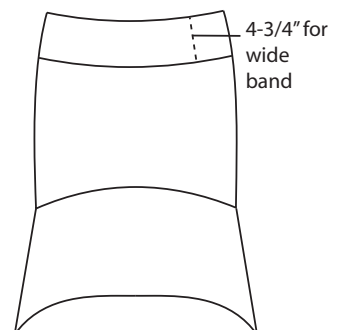
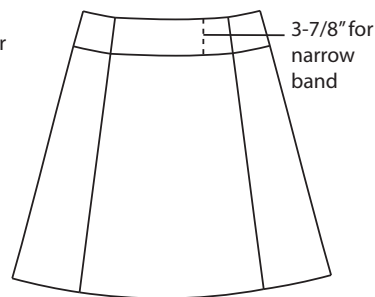
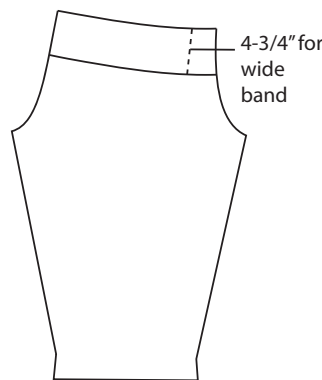

- Construct the pants or skirt per the instructions, eliminating the elastic at the waist.

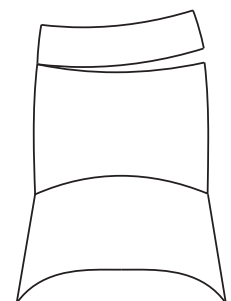
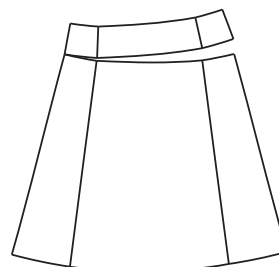
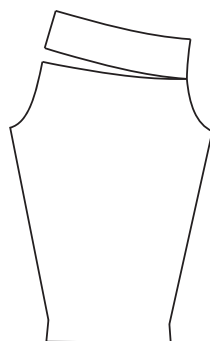

- Serge the two short sides of the band together to form a tube. Fold the tube in half with the wrong sides together. Edge serge the raw edges together.

- Quarter the band and quarter the top edge of the pants or skirt. Serge the band onto the garment with the band seam at the center back.

BAND MEASUREMENT CHART

Wide Band – Finished width 5-3/8"

Cut 4-3/4" off the top of the pattern

Cut the band 12" wide

Narrow Band – Finished width 3-7/8"

Cut 3-7/8" off the top of the pattern

Cut the band 9" wide

Calculate Band Length

This is to ensure the correct "tightness" of the band (also known as **negative ease**). *These tips are an approximation.* You'll need to experiment with your band fabric, garment fabric and your body.

Measure your high hip/low waist (belly button level). Multiply this measurement by 78% and add two seam allowances (5/8" x 2 = 1-1/4"). Cut the band to this length on the crosswise grain.

$$(\text{High Hip Measurement} \times 78\%) + 1\text{-}1/4 = \text{Length of Band}$$

example: for a 36" high hip $(36 \times 78\%) + 1\text{-}1/4 = 28 + 1\text{-}1/4 = 29\text{-}1/4$ "

For a wide band, the fabric would be cut 12" x 29-1/4"

- If attaching a knit band to a woven garment cut the band slightly longer, about 2 inches.
- If the knit chosen for the band has less than 100% stretch, for every 10% less stretch, add 1 inch to the length.

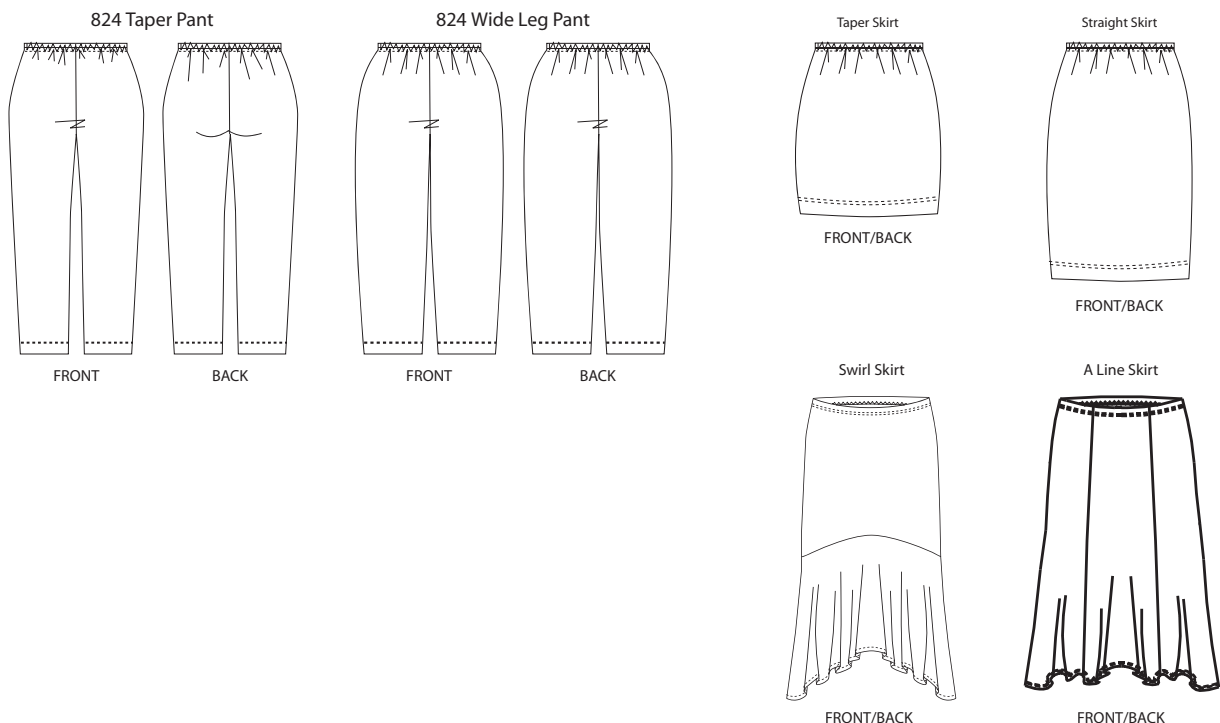

Fabric Band Photo Information

Fabric Band 1

Woven fabric skirt and Rayon/LYCRA® Jersey band
A Line Skirt and Princess Wrap Top - *Detail View*

Fabric Band 2

Woven fabric skirt and Rayon/LYCRA® Jersey band
A Line Skirt and Princess Wrap Top - *Full View*

Fabric Band 3

Rayon/LYCRA® Jersey
Swirl Skirt with band folded in half - *Detail View*

Fabric Band 4

Rayon/LYCRA® Jersey
Swirl Skirt with band scrunched down - *Detail View*

Fabric Band 5

Rayon/LYCRA® Jersey
Swirl Skirt with full band - *Detail View*

Fabric Band 6

Rayon/LYCRA® Jersey
Swirl Skirt - *Full View*



Fabric Band 1

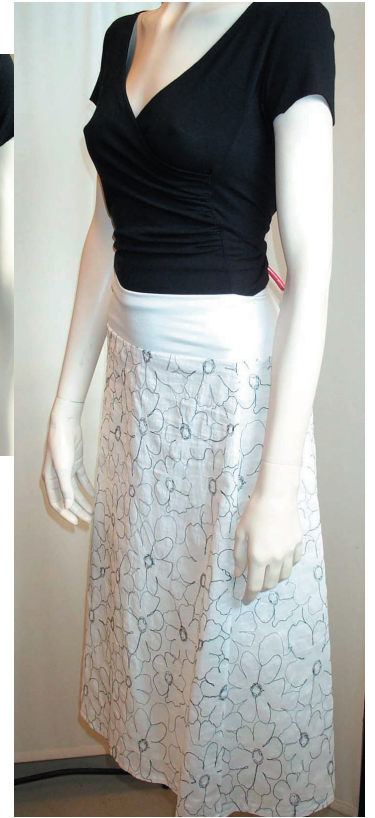

Fabric Band 2



Fabric Band 3



Fabric Band 4



Fabric Band 5



Fabric Band 6

Fabric Band 7

Rayon/LYCRA® Jersey

Swirl Skirt and Reversible Keyhole Top
(shown without keyhole)



Fabric Band 7

Fabric Band 8

Rayon/LYCRA® Jersey (Solid color and print)

Swirl Skirt and Reversible Keyhole Top
(shown without keyhole)



Fabric Band 8

Fabric Band 9

Rayon/LYCRA® Jersey

Swirl Skirt *Detail View*

Band pulled down over hip



Fabric Band 9

Fabric Band 10

Rayon/LYCRA® Jersey

Taper Pant with wide band - *Detail View*

Fabric Band 11

Rayon/LYCRA® Jersey

Taper Pant with band scrunched down

Shown with future top pattern

Fabric Band 12

Rayon/LYCRA® Jersey

Taper Pant shown with Sleeveless Wrap Top

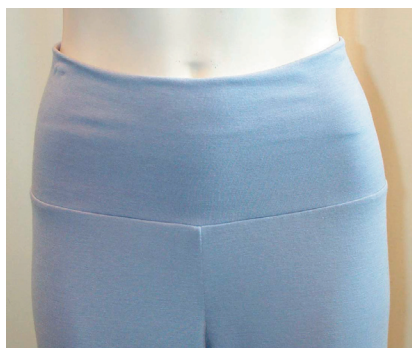

Fabric Band 10



Fabric Band 11



Fabric Band 12